

Article number: 604144056085

Description: Timing belt pulley with hub
HTD 56 8M 85

Measures

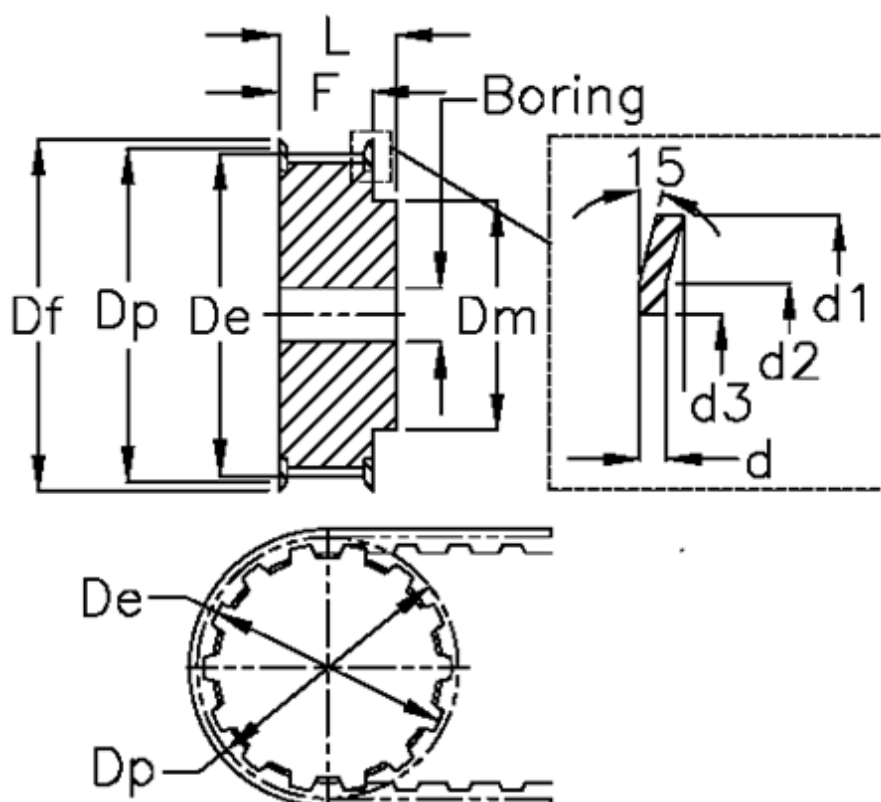

Bore = 18	Dp	= 142.6
d = 1.5	F	= 95
d1 = 150	Flange type	= F48
d2 = 145	L	= 105
d3 = 130	Tooth number	= 56
De = 141.23	Type	= 8M
Df = 150	Weight	= 10
Dm = 90	Width	= 85